

# CHAIN REPLACEMENT - MODEL C,D,E

0607

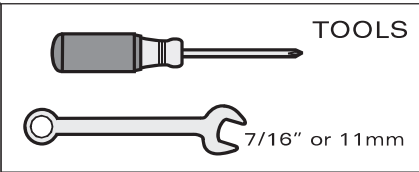

concept2.com

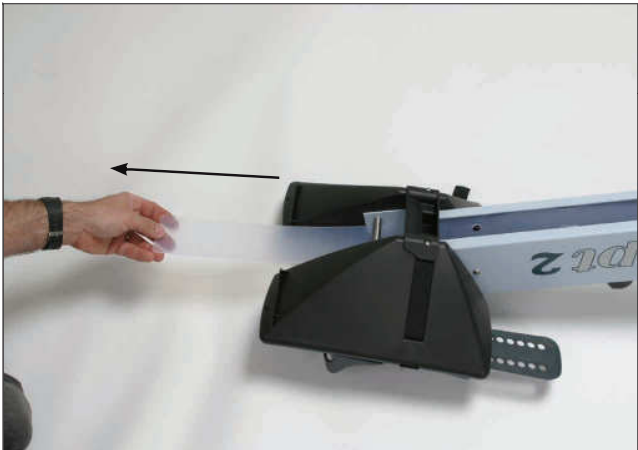

# CHAIN REPLACEMENT - MODEL C,D,E

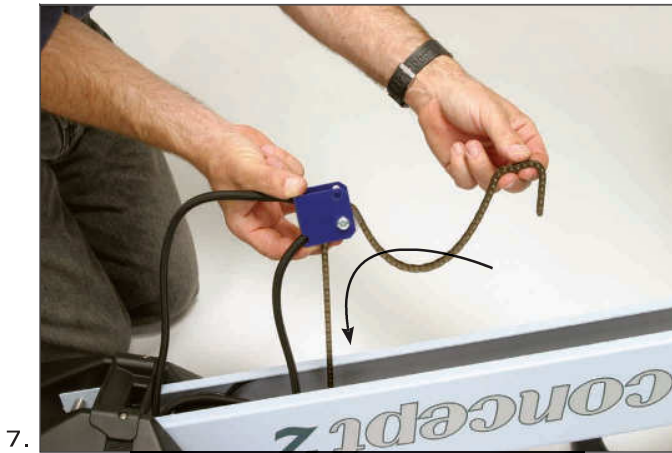

7.



8.



9.

**Note:**  
 If your rower has a wooden handle, follow steps 10-14.  
 If your rower has a plastic handle, follow steps 15-17.



10.

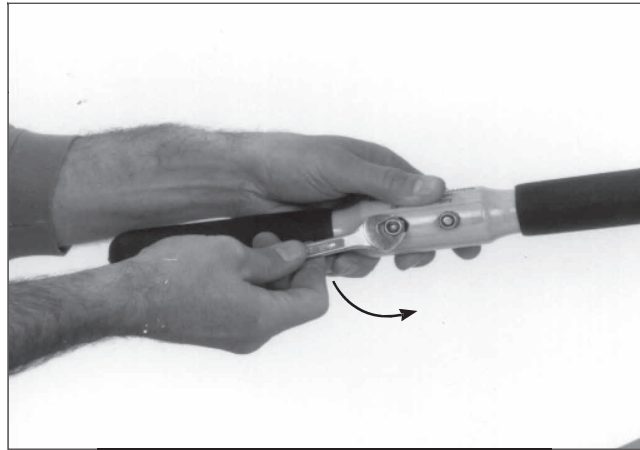

11.

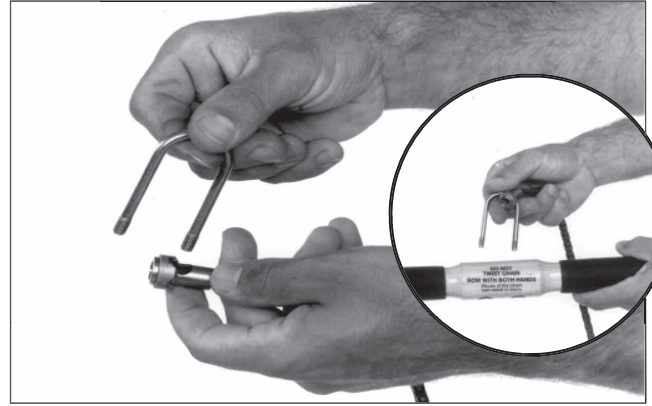

12. Remove old chain and replace with new chain.

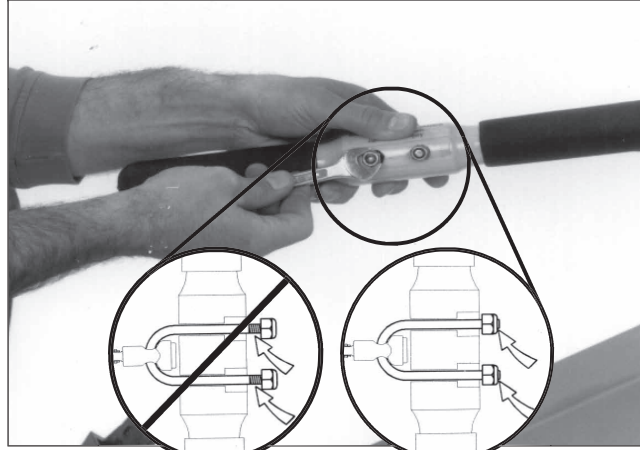

13.



14. Proceed to step 18.

# CHAIN REPLACEMENT - MODEL C,D,E

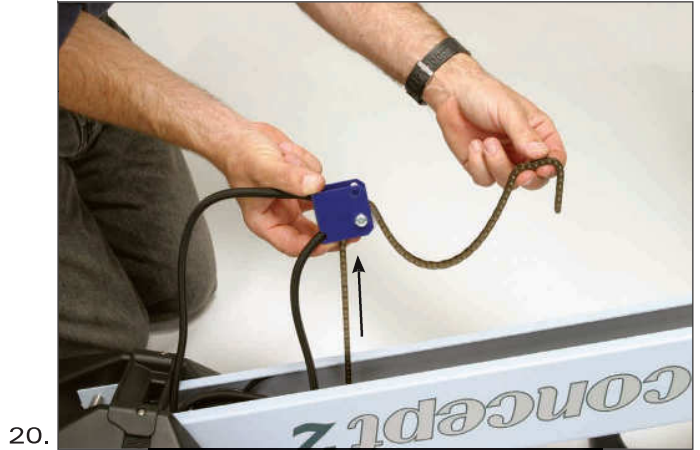
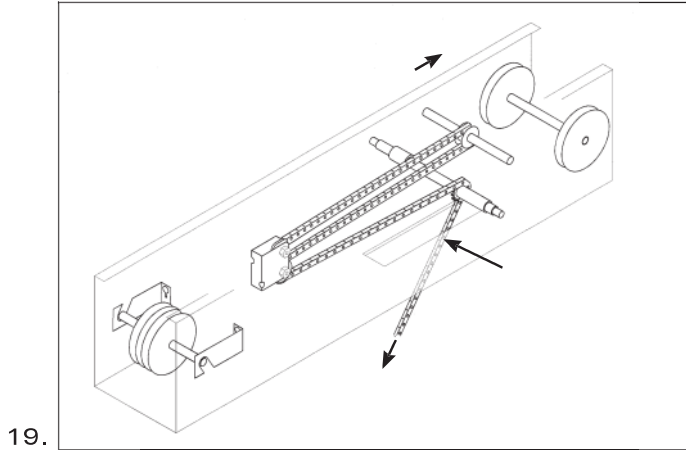
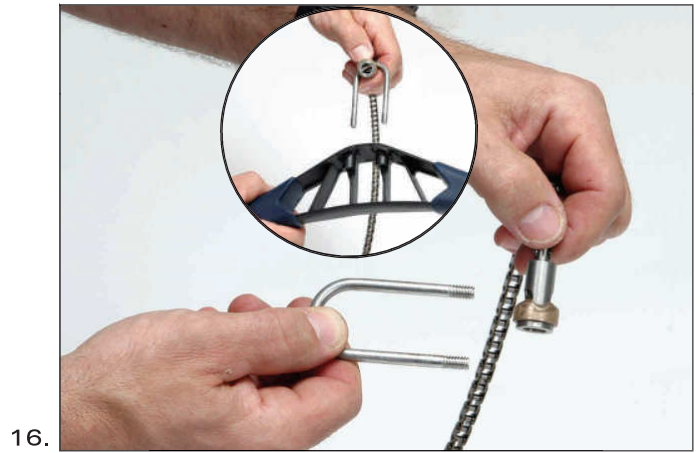

## CHAIN REPLACEMENT - MODEL C,D,E

